

Specifications

Nominal Voltage (V)		12	
Nominal Capacity (AH)		4.5	
Dimensions	Length	90 mm	3.54 inch
	Width	70 mm	2.76 inch
	Height	101 mm	3.98 inch
	Total Height	105 mm	4.13 inch
Approx. Weight		1.50 kgs	3.31 lbs
Standard Terminals Case Material		Faston Tab 250/187 ABS UL 94-HB	

Characteristics

Capacity	20 hour rate	0.25 A	5.00 Ah
	10 hour rate	0.46 A	4.60 Ah
	5 hour rate	0.80 A	4.00 Ah
	1 hour rate	3.40 A	3.40 Ah
	15 Min Rate	9.20 A	2.30 Ah
Internal Resistance		35 mΩ	
Max. Discharge Current (5 sec)		70 A	
Constant Voltage Charge Method	Max. Charge Current	1.6 A	
	Standby Use	2.25 - 2.30 V /Cell	
	Cycle Use	2.40 - 2.50 V /Cell	
Operating Temperature Range	Discharge:	-15 ~ 50 °C (5 ~ 122 °F)	
	Charge:	-15 ~ 40 °C (5 ~ 104 °F)	
	Storage:	-15 ~ 40 °C (5 ~ 104 °F)	
Temperature coefficient	For standby use:	-3.3mV / °C /Cell	
	For cycle use:	-5.0mV / °C /Cell	
Self discharge 25°C (77°F)	After 3-month	91%	
	After 6-month	82%	
	After 12-month	64%	
Temperature dependency of Capacity	40 °C (104 °F)	102%	
	25 °C (77 °F)	100%	
	0 °C (32 °F)	85%	
	-15 °C (5 °F)	65%	

Discharge Voltage vs Discharge Current

Final Voltage V/Cell	1.75	1.70	1.60	1.30
Discharge Current (A)	0.2C>(A)	0.2C<(A)<0.5C	0.5C<(A)<1.0C	(A)>1.0C

Dimensions

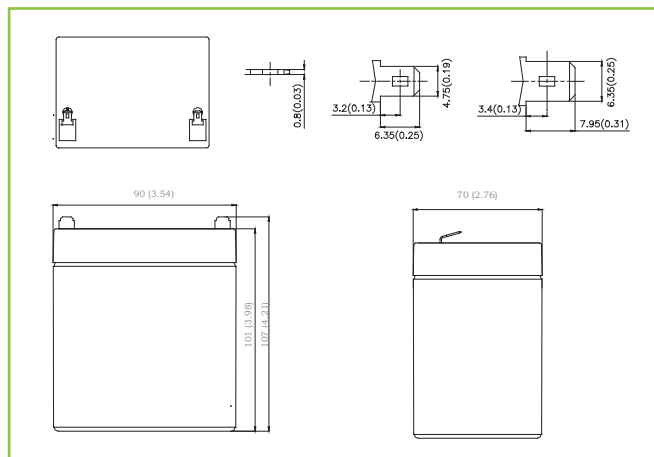

LV 5-12

LV 5-12 VRLA (valve-regulated lead acid) battery is designed for general purpose application with 5 years standby life at 25°C. This battery is rechargeable, highly-efficient, leak-proof and maintenance-free.

LivEn is ISO9001 and UL certified for quality assurance.



Terminal Voltage (V) and Discharge Time

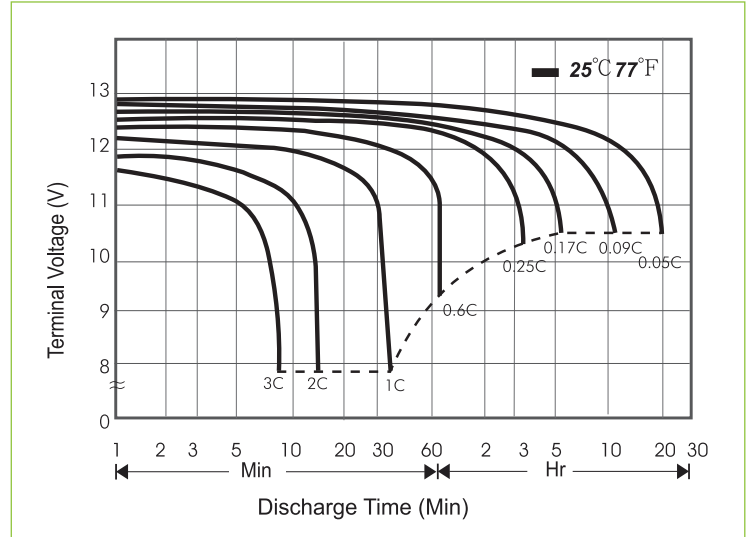

Battery Voltage and Charge Time for Standby Use

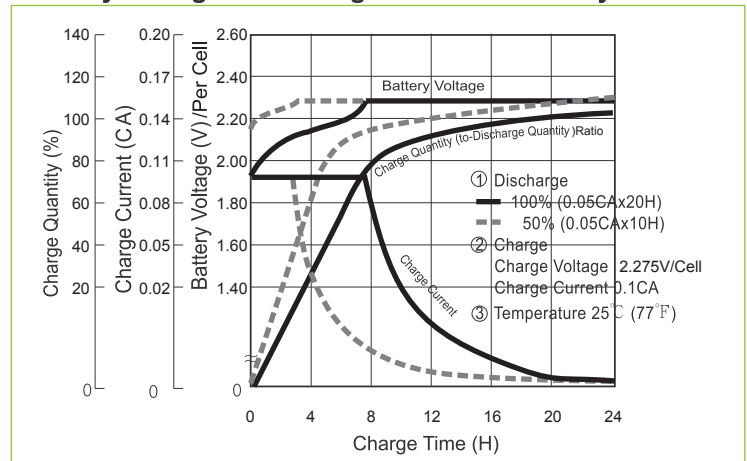

Cycle Service Life

